

Data Sheet



Article number: 12620000040710

Description: Threaded pin 620 000 040.710
For M4

Measures

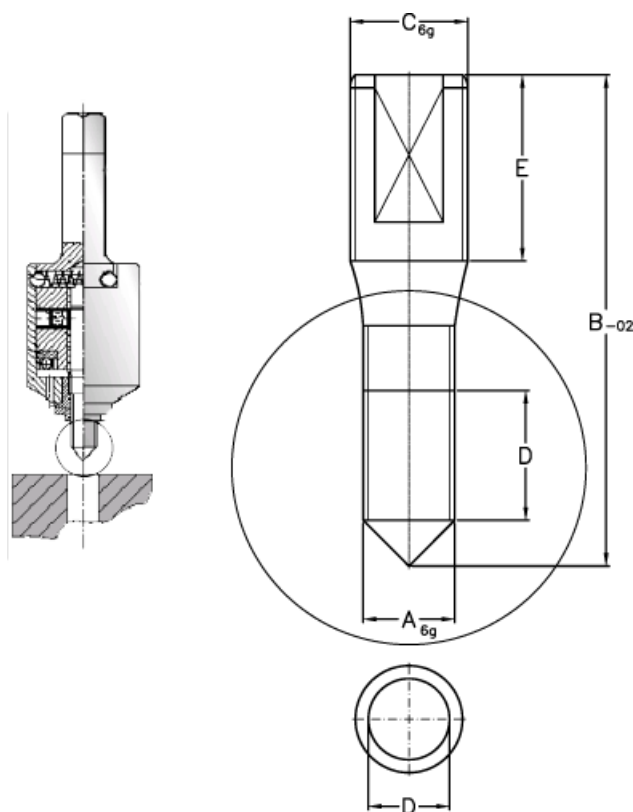

A = M4
B = 31.0
C = M4
D = 8.3
E = 13